

OPERATING AND SERVICE MANUAL

HP35676A/HP35676B

REFLECTION/TRANSMISSION TEST KIT

Manual Part Number 35676-90000

Microfiche Part Number 35676-90200

**COPYRIGHT ©, 1985 HEWLETT-PACKARD COMPANY
8600 Soper Hill Road, Everett, Washington 98205-1298**

PRINTED FEBRUARY 1985

PRINTED IN U.S.A.



WARRANTY

This Hewlett-Packard product is warranted against defects in material and workmanship for a period of one year from date of shipment. During the warranty period, Hewlett-Packard Company will, at its option, either repair or replace products which prove to be defective.

For warranty service or repair, this product must be returned to a service facility designated by -hp-. Buyer shall prepay shipping charges to -hp- and -hp- shall pay shipping charges to return the product to Buyer. However, Buyer shall pay all shipping charges, duties, and taxes for products returned to -hp- from another country.

LIMITATION OF WARRANTY

The foregoing warranty shall not apply to defects resulting from improper or inadequate maintenance by Buyer, Buyer-supplied software or interfacing, unauthorized modification or misuse, operation outside of the environmental specifications for the product, or improper site preparation or maintenance.

NO OTHER WARRANTY IS EXPRESSED OR IMPLIED. HEWLETT-PACKARD SPECIFICALLY DISCLAIMS THE IMPLIED WARRANTIES OF MERCHANTABILITY AND FITNESS FOR A PARTICULAR PURPOSE.

EXCLUSIVE REMEDIES

THE REMEDIES PROVIDED HEREIN ARE BUYER'S SOLE AND EXCLUSIVE REMEDIES. HEWLETT-PACKARD SHALL NOT BE LIABLE FOR ANY DIRECT, INDIRECT, SPECIAL, INCIDENTAL, OR CONSEQUENTIAL DAMAGES, WHETHER BASED ON CONTRACT, TORT, OR ANY OTHER LEGAL THEORY.

ASSISTANCE

Product maintenance agreements and other customer assistance agreements are available for Hewlett-Packard products.

For any assistance, contact your nearest Hewlett-Packard Sales and Service Office. Addresses are provided at the back of this manual.



HEWLETT
PACKARD

SAFETY SUMMARY

No special safety requirements are required for this product. Refer to the HP 3577A manual set for safety notes to be followed when the HP 35676A/B is used with the HP 3577A.

SAFETY SYMBOLS

CAUTION

The CAUTION sign denotes a hazard. It calls attention to an operating procedure, practice, condition or the like, which, if not correctly performed or adhered to, could result in damage to or destruction of part or all of the product.

TABLE OF CONTENTS

OPERATION

Introduction	1
Description	2
Inspection	5
Signal Divider Connections	5
Input and Output Levels	6
One Port Measurements	7
One Port Calibration	7
Reflection Coefficient/Return Loss	8
Complex Impedance	9
Two Port Measurements	9
Two Port Calibration	10
Transmission Measurements	11

SERVICE

Obtaining Service	13
Operation Verification Test Record	13
Recommended Test Equipment	13
Operational Verification of Signal Divider	13
Verification Test with HP 3577A	14
Verification Test with Signal Generator and Power Meter	17
Adjustment	19
Maintenance/Repair	19
Disassembly	19
Assembly	20
Replaceable Parts List	22
Operational Verification Test Record	24

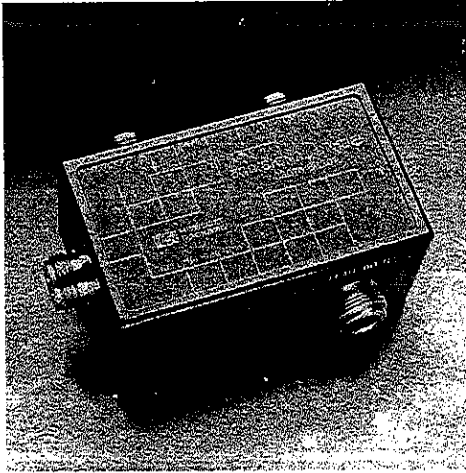

OPERATION

INTRODUCTION

The HP 35676A and HP 35676B Reflection/Transmission Test Kits contain components to assist the HP 3577A Network Analyzer in performing calibrated complex reflection and transmission measurements over the frequency range of 5 Hz to 200 MHz. The HP 35676A Reflection/Transmission Test Kit has a 50 Ω test port impedance while the HP 35676B Reflection/Transmission Test Kit has a 75 Ω test port impedance. Table 1 lists the operating characteristics of the HP 35676A/B Reflection/Transmission Test Kit.

The following typical, but non-warranted, performance characteristics are supplied to provide assistance in understanding and applying this product. All are typical for frequencies between 5 Hz and 200 MHz, after calibration with supplied accessories.

Test Port Impedance: 50 Ω \pm 2% typical (HP 35676A)
75 Ω \pm 2% typical (HP 35676B)

Insertion Loss (source input to test output):
10 \pm 1 dB typical

Equivalent Directivity: >40 dB typical

Equivalent Source Match: >30 dB typical (HP 35676A)
>25 dB typical (HP 35676B)

Table 1. Operating Characteristics

DESCRIPTION

The HP 35676A Reflection/Transmission Test Kit is designed to operate in 50 Ω environments, and contains 50 Ω components exclusively. See Figure 1. The HP 35676B Reflection/Transmission Test Kit is designed to make measurements in 75 Ω systems while still interfacing to the 50 Ω HP 3577A. As a result, it contains both 50 Ω and 75 Ω components. See Figure 2.

CAUTION

Avoid connecting 50 Ω connectors to 75 Ω connectors. The 75 Ω connector center pin is smaller than the 50 Ω connector center pin. Mating a 50 Ω male center pin to the 75 Ω female center pin can damage the 75 Ω center pin. 75 Ω connectors are used in the HP 35676B Reflection/Transmission Test Kit in the following places:

- 75 Ω signal divider test port (blue label)
- 11852A 50 Ω /75 Ω minimum loss pad
- 909E 75 Ω termination (blue color code)
- 1250-1530 shorting plug

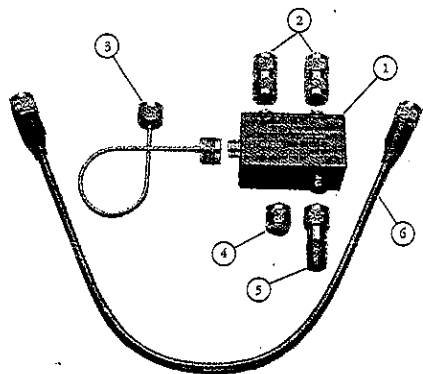

Figure 1. HP 35676A Components

Reference Number	Description	Quantity	Part Number
1	50 Ω Signal Divider	1	35676-66301
2	Adapter Type N 50 Ω Male-to-Male	2	1250-1475
3	Semi-rigid Cable 50 Ω Type N Male-to-Male	1	35676-61601
4	Male Shorting Plug	1	11512A
5	50 Ω Termination	1	909C
6	Cable 50 Ω (60 cm) Type N Male-to-Male	1	Options 201, 012 35676-61602
	Case	1	1540-0964
	Foam Insert	1	35676-50801
	Label-case	1	35676-34307
	Operating Note	1	35676-90000

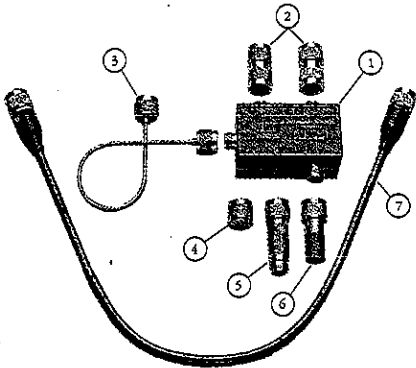

Figure 2. HP 35676B Components

Reference Number	Description	Quantity	Part Number
1	75 Ω Signal Divider	1	35676-66302
2	Adapter Type N 50 Ω Male-to-Male	2	1250-1475
3	Semi-rigid Cable 50 Ω Type N Male-to-Male	1	35676-61601
4	Male Shorting Plug	1	1250-1530
5	75 Ω Termination	1	909E Options 201, 012
6	50 Ω /75 Ω Minimum Loss Pad	1	11852A
7	Cable 50 Ω (60 cm) Type N Male-to-Male	1	35676-61602
	Case	1	1540-0964
	Foam Insert	1	35676-50801
	Label-case	1	35676-34308
	Operating Note	1	35676-90000

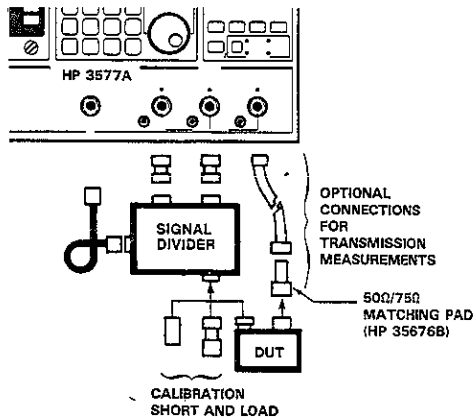

Figure 3. Signal Divider Connections

INSPECTION

The HP 35676A/B Reflection/Transmission Test Kit is carefully inspected both mechanically and electrically before shipment. It should be free of marks or scratches and in perfect electrical order upon receipt. If damage occurs in transit, file a claim with the carrier. Check for supplied accessories and test the electrical performance using the Verification Test in this Operating Manual. If there is damage or deficiency, see the warranty at the front of this Operating Manual. For any problems, feel free to contact your local HP Sales and Service Office.

SIGNAL DIVIDER CONNECTIONS

The HP 35676A/B signal divider is designed to mount directly to the HP 3577A. Figure 3 illustrates the connections. The HP 3577A RECEIVER R and RECEIVER A ports connect to the signal divider OUTPUT R and OUTPUT A ports with the male-to-male type N adapters. The HP 3577A SOURCE OUTPUT port connects to the signal divider RF INPUT port with the semi-rigid coaxial cable assembly.

NOTE

Ensure that the A and R port connectors are fully seated when the signal divider is connected to the HP 3577A. If the A and R port connectors are not fully seated, the HP 3577A may display erratic measurements. The device under test connects to the signal divider TEST 50 Ω (HP 35676A) or the TEST 75 Ω (HP 35676B) port. The flexible coaxial cable connects the test device output to the HP 3577A RECEIVER B port to allow transmission measurements. A 75 Ω to 50 Ω minimum loss pad is included with the HP 35676B for matching the flexible cable and HP 3577A 50 Ω RECEIVER B port to 75 Ω test devices.

INPUT AND OUTPUT LEVELS

The signal divider is designed for maximum compatibility with normal HP 3577A input and output levels. At most frequencies, it operates over the entire source power range of the HP 3577A without overload. Below 10 kHz, however, it may be necessary to limit source power to +5 dBm or less to prevent overload of the HP 3577A's receiver inputs.

Due to insertion losses, the power available at the signal divider test port is approximately 10 dB less than that applied to the RF INPUT. Attenuation between the RF INPUT and OUTPUT R or OUTPUT A ports is nominally 15 dB.

Up to 0.25 watts of power may be applied to the signal divider test port without causing damage. Power applied to the signal divider test port does not affect measurement accuracy.

CAUTION

Power above 0.25 watts applied to the signal divider input can damage signal divider components. The signal divider may be checked for damaged components by performing the Verification Test located in this Operating Note.

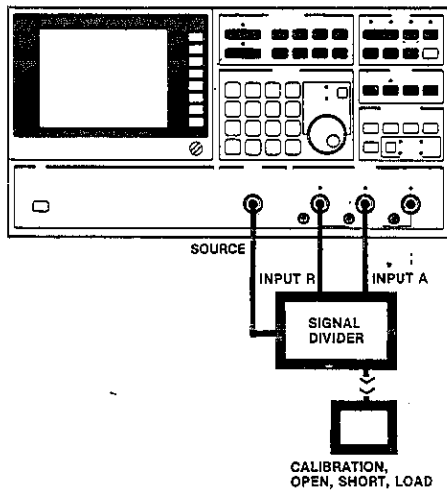

Figure 4. Reflection Calibration

ONE PORT MEASUREMENTS

One Port Calibration. The HP 35676A/B Reflection/Transmission Test Kit is calibrated for reflection measurements by using the internal one port full calibration function of the HP 3577A. The calibration function requires that a short, open, and reference load be attached in place of a test device during calibration. A complete description of the HP 3577A calibration procedure is in the HP 3577A Network Analyzer Operating Manual. Figure 4 and the following procedures describe calibration when the test device is attached directly to the signal divider test port:

1. Set up the measurement (Input, Display Function, Frequency, Amplitude)
2. Press the MEASR CAL hardkey to display the calibration menu.
3. Press the ONE PORT FULL CAL softkey to select single port calibration.
4. When the HP 3577A displays a screen message to LEAVE PORT 1 OPEN, open circuit the signal divider test port.
5. Press the CONTINUE CAL softkey.
6. When the HP 3577A displays a screen message to INSTALL SHORT ON PORT 1, connect a short, 0Ω impedance, to the signal divider test port. A shorting plug is included in the test kit.
7. Press the CONTINUE CAL softkey.

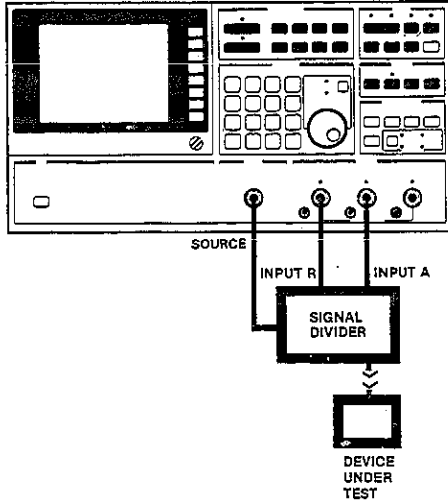

Figure 5. One Port Measurement

8. When the HP 3577A displays the screen message INSTALL LOAD ON PORT 1, terminate the signal divider test port in its characteristic impedance. A termination is included in the test kit.
9. Press the CONTINUE CAL softkey.
10. When the HP 3577A displays a screen message to CALIBRATION COMPLETE, remove the termination from the test port.
11. The HP 3577A is now ready to make measurements.

NOTE

The HP 3577A is also able to calibrate and compensate for external cables and test adapters connected between the signal divider and device under test. When calibrating with external cables and test adapters, simply apply the short, open, and reference load at the physical point where the test device will be connected.

Reflection Coefficient/Return Loss. After one port calibration, the HP 3577A is automatically configured to display the reflection coefficient or return loss of the device connected to the test port (see Figure 5). The calibration procedure selects USER DEF INPUT F2, which is defined as corrected A/R, for display by the active trace. The reflection coefficient is displayed by selecting LIN MAG display function, and return loss is displayed by selecting LOG MAG display function. Alternating between the LIN MAG and LOG MAG display function redispays the measurement in the new format; thus recalibration is unnecessary.

Complex Impedance. Complex impedance measurements are made by using the HP 3577's vector math functions to convert reflection coefficient into impedance. The preset USER DEF INPUT F3 calculates normalized impedance. Absolute impedance is obtained from normalized impedance with the preset USER DEF INPUT F4 and USER DEF INPUT F5 functions. For the 50 Ω HP 35676A, USER DEF INPUT F4 multiplies normalized impedance by 50 Ω for absolute impedance. Similarly, for the 75 Ω HP 35676B, USER DEF INPUT F5 multiplies normalized impedance by 75 Ω to obtain absolute impedance.

TWO PORT MEASUREMENTS

NOTE

The HP 3577A and HP 35676A/B Reflection/Transmission Test Kit can be calibrated for both reflection and transmission measurements concurrently. However, one trace on the HP 3577A must be selected for a reflection calibration, and the other trace must be selected for the transmission calibration (e.g. calibrate trace 1 for reflection measurements and trace 2 for transmission measurements). Using both traces is necessary to avoid conflicts among the internal data registers that contain calibration data.

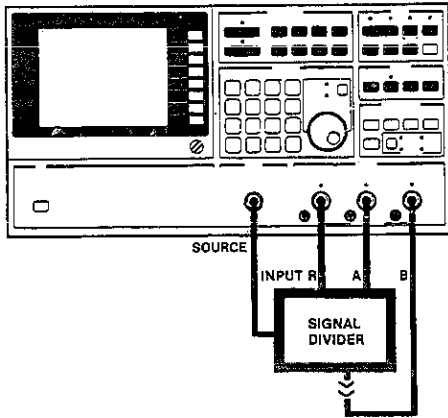

Two Port Calibration. The HP 35676A/B Reflection/Transmission Test Kit is calibrated for transmission measurements using the internal NORMALIZE calibration function of the HP 3577A. The calibration function requires that a through connection (0 dB loss) be attached in place of a test device during calibration. A complete description of the HP 3577A calibration procedure is in the HP 3577A Network Analyzer Operating Manual. Figure 6 and the following procedure describes two port calibration when the test device is attached directly to the signal divider test port:

1. Set up the measurement (Input, Display Function, Frequency, Amplitude)
2. Connect the flexible cable (and 50 Ω /75 Ω minimum loss pad for the HP 35676B) between the signal divider test port and the HP 3577A RECEIVER B port.

NOTE

When the signal divider test port is connected directly to the HP 3577A RECEIVER B port, limit the signal divider RF INPUT power to 0 dBm or less. RF INPUT power greater than 0 dBm can overload the HP 3577A B receiver input circuit.

3. Press the MEASR CAL hardkey to display the calibration menu.
4. Press the NORMALIZE softkey.
5. The HP 3577A is now ready to perform transmission measurements.

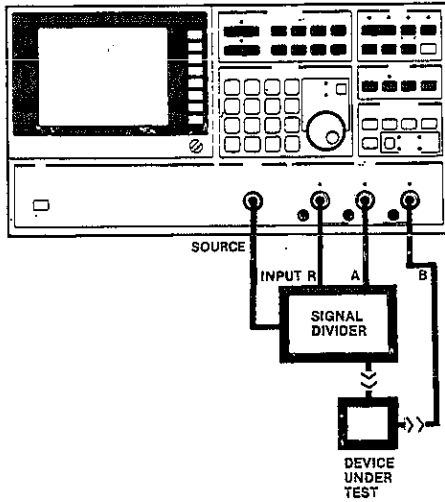

Figure 7. Two Port Transmission Measurement

Transmission Measurements. By using the HP 3577A's transmission calibration and ratio measurement functions, the gain or loss of the device under test can be displayed directly in decibels or linear ratio units. The transmission calibration function removes the effects of the HP 35676A/B Signal Divider and connecting cables. The HP 3577A measurement function B/R calculates the gain or loss of the test device. The test device is connected between the signal divider test port and the HP 3577A RECEIVER B port with the flexible cable included in the test kit. See Figure 7.

SERVICE

OBTAINING SERVICE

If the HP 35676A/B Reflection/Transmission Test Kit is being returned to Hewlett-Packard for servicing, attach a tag indicating the type of service required, return address, and HP 35676A/B model number. Mark the shipping container FRAGILE to ensure careful handling. In any correspondence, refer to the HP 35676A/B by model number. Addresses of Sales and Support Offices may be found in the back of the HP 3577A Operating or Service Manuals.

OPERATION VERIFICATION TEST RECORD

An Operational Verification Test Record is provided at the end of this Operating Note to record the results of the Operational Verification Test. The form may be removed and retained as a permanent record of the incoming inspection or routine maintenance performed on the instrument. It may be reproduced without written permission from Hewlett-Packard.

RECOMMENDED TEST EQUIPMENT

The test equipment that is recommended for maintenance of the signal divider is listed in Table 2 and 3. If the recommended model is not available, use an instrument that has specifications equal to or better than those listed.

OPERATIONAL VERIFICATION OF SIGNAL DIVIDER

The HP 35676A/B is tested for proper performance by measuring the insertion loss between the RF INPUT and test port. Two test procedures are provided for testing the signal divider insertion loss. Use the test procedure that is suitable for available test equipment.

NOTE

If the HP 35676A/B measurement results are inconsistent, check that the A and R port connectors are fully seated. For inconsistent transmission measurements, inspect the flexible cable and its connections. The flexible cable internal braiding may also break with extended use without the cable appearing worn.

VERIFICATION TEST WITH HP 3577A

**Table 2. Recommended Test Equipment
(HP 3577A Test)**

Description	Model	Required Specifications
Signal Analyzer	HP 3577A	Frequency: 200 MHz Amplitude: 0 dBm

NOTE

The test procedures use adapters and connectors from the HP 35676A/B Reflection/Transmission Test Kit. The following components for the test procedure are found in the test kit:

Description	HP Part Number
Adapter Type N 50 Ω Male-to-Male (2 required)	1250-0778
Semi-rigid Cable 50 Ω Type N Male-to-Male	35676-61601
50 Ω /75 Ω Minimum Loss Pad (HP 35676B only)	11852A
Flexible Cable 50 Ω (60 cm) Type N Male-to-Male	35676-61602

Test Procedure

1. Press INSTR PRESET on the HP 3577A.
2. Press FREQ and set the HP 3577A SOURCE start frequency to 10 kHz.
3. Press AMPTD and set the HP 3577A SOURCE amplitude to -2 dBm.
4. Connect the flexible cable from the HP 35676A/B test kit between the HP 3577A SOURCE output and B RECEIVER INPUT.

Test Procedure (Cont'd)

5. Press INPUT and select input B as the DISPLAY FORMAT.
6. Press the MEASR CAL hardkey, then press the NORMALIZE (SHORT) softkey. This key sequence stores the B input trace in data register D1 and defines the user defined function B/D1.
7. Disconnect the flexible cable from SOURCE OUTPUT.
8. Connect the signal divider RF INPUT, OUTPUT A, and OUTPUT R ports to the HP 3577A with the connectors supplied with the HP 35676A/B test kit. See Figure 3.
9. For the HP 35676B, connect the HP 11852A 75 Ω minimum loss pad to the signal divider TEST 75 Ω port.
10. Connect the HP 3577A B RECEIVER input to the signal divider TEST 50 Ω port (HP 35676A) or the 75 Ω minimum loss pad connected to the signal divider TEST 75 Ω port.
11. Record the marker value for B/D1 at 200 MHz on the Operation Verification Test Record. The value for B/D1 should be:
 - 10 \pm 1 dB (HP 35676A).
 - or
 - 15.7 \pm 1 dB (HP 35676B)

NOTE

The 75 Ω minimum loss pad increases the HP 35676B signal divider insertion loss from -10 dB to -15.7 dB.

**VERIFICATION TEST
POWER METER**

SIGNAL GENERATOR AND

Table 3. Required Equipment (Signal Generator and Power Meter Test)

Description

Signal Generator

Power Meter

Power Sensor

Terminations (2

Required Specifications

Frequency: 200 MHz
Amplitude: 0 dBm
Frequency: 200 MHz
Amplitude: -15.7 to 0 dBm
Frequency: 200 MHz
Amplitude: -15.7 to 0 dBm
Impedance: 50 Ω
Connector: Type N Male

The test procedure is described in the Test Kit. The test procedure is described in the Test Kit.

and connectors are described in the Test Kit. The test procedure is described in the Test Kit.

Description
Adapter Type
Male-to-Male
50 Ω
Minimum Loss
(HP 35676B)

HP Part Number

1250-0778

11852A

Test Procedure

1. Set the signal generator output for a frequency of 200 MHz and level of 0 dBm.
 2. Calibrate the power meter and sensor with the power reference on the power meter.
 3. Set the power meter to measure the 0 dBm signal generator output.
 4. Connect the power sensor to the signal generator RF OUTPUT and record the power meter reading.
 5. Terminate the signal divider R and A ports with 50 Ω terminations.
 6. If testing HP 35676B signal divider, connect the HP 11852A 75 Ω minimum loss pad from the HP 35676B test kit to the signal divider 75 Ω TEST output.
 7. Connect the signal generator RF OUTPUT to the signal divider RF INPUT port with a male-to-male adapter included with the HP 35676A/B test kit.
 8. Connect the power sensor to the signal divider TEST 50 Ω port (HP 35676A) or connect the power sensor to the 75 Ω minimum loss pad connected to the signal divider TEST 75 Ω port.
 9. Record the power meter reading.
 10. The difference between the readings in step 4 and step 9 should be:
 - 10 \pm 1 dB (HP 35676A)
 - or
 - 15.7 \pm 1 dB (HP 35676B)
-

NOTE

The 75 Ω minimum loss pad increases the HP 35676B signal divider insertion loss from -10 dB to -15.7 dB.

ADJUSTMENT

The HP 35676A/B Reflection/Transmission Test Kit does not require adjustment.

MAINTENANCE/REPAIR

The HP 35676A/B Reflection/Transmission Test Kit does not require periodic maintenance.

Figure 8 illustrates the replaceable components for the HP 35676A/B. Repair of the signal divider circuits is accomplished by replacing the printed circuit assembly within the signal divider cavity.

Disassembly:

- Peel the signal divider labels off with a thin bladed screwdriver.
- Remove the signal divider cover plate screws and cover plate.
- Remove the signal divider connectors.
- Remove the circuit board retaining screws and circuit board.

Assembly:

- Place the circuit board in signal divider cavity and secure with screws.

NOTE

Observe orientation of wire leads when installing circuit board.

- Slip the type N connector center pin over the wire lead of the circuit board and seat the center pin in the recess of the signal divider. The connections between the circuit board and type N connector center pins are solderless.

CAUTION

When replacing the connectors on the HP 35676B signal divider, ensure that the 75 Ω center pin is used for the test port connector. The diameter of the 75 Ω center pin is smaller than the diameter of the 50 Ω center pin. Mating a 50 Ω center pin to a 75 Ω center pin can damage the pins.

- Slip the N connector shell over the center pin in the signal divider and secure with screws.
- After the connectors are secured, replace the cover and secure with screws.
- Replace the labels after testing the signal divider.

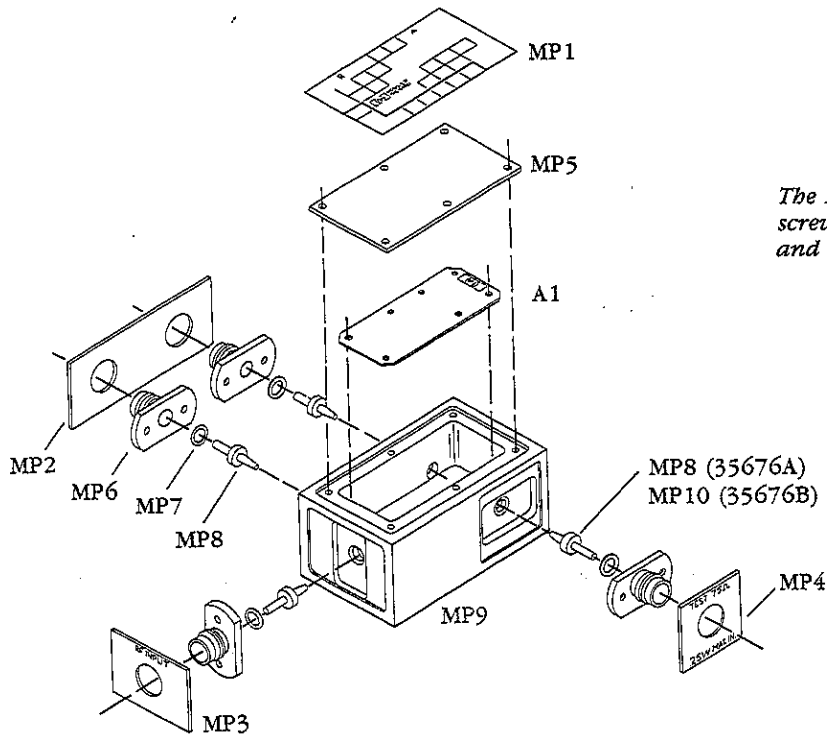

CAUTION

The HP 35676A/B Signal Divider contains metric screws. Refer to the parts list for the part numbers and description of the screws.

Figure 8. Replaceable Parts

HP 35676A/HP 35676B

REPLACEABLE PARTS LIST

HP 35676A

Reference Designation	HP Part Number	C D	Qty	Description	Mfr Code	Mfr Part Number
A1	35676A	7	1	TRANS/REFL TEST KIT 50 OHM	28480	35676A
	35676-66501	9	1	PC BOARD-50 OHM SIGNAL DIVIDER	28480	35676-66501
	35676-64301		1	LABEL KIT-50 OHM SIGNAL DIVIDER	Q01008	
MP1	35676-34301	0	1	LABEL-TOP	Q01008	
MP2	35676-34303	2	1	LABEL-OUTPUT	Q01008	
MP3	35676-34302	3	1	LABEL-INPUT	Q01008	
MP4	35676-34304	3	1	LABEL-TEST	A01224	
MP5	35676-04101	5	1	HOUSING COVER		
MP6	1250-0549	4	4	BODY-RF CONNECTOR TYPE N FEMALE BODY	28480	1250-0549
MP7	08742-0006	5	4	SPACER OUTER COND	28480	08742-0006
MP8	35676-62101	7	4	INNER CONDUCTOR ASSY-50 OHM	28480	35676-62101
MP9	35676-26301	3	1	HOUSING-DIVIDER	A01224	
	0515-0999	9	14	SCREW-MACH M2.5 X 0.45 6MM-LG		
	0515-0905	7	7	SCREW-MACH M2.5 X 0.45 6MM-LG PAN-HD	M01088	

REPLACEABLE PARTS LIST

HP 35676B

Reference Designation	HP Part Number	C D	Qty	Description	Mfr Code	Mfr Part Number
	35676B	9	1	TRANS/REFL TEST KIT 75 OHM	28480	35676B
A1	35676-66502	0	1	PC BOARD-75 OHM SIGNAL DIVIDER	28480	35676-66502
	35676-64302		1	LABEL KIT-75 OHM SIGNAL DIVIDER	Q01008	
MP1	35676-34305	4	1	LABEL-TOP	Q01008	
MP2	35676-34306	5	1	LABEL-OUTPUT	Q01008	
MP3	35676-34302	1	1	LABEL-INPUT	Q01008	
MP4	35676-34304	3	1	LABEL-TEST	Q01008	
MP5	35676-04101	5	1	HOUSING-COVER A01224		
MP6	1250-0549	4	4	BODY-RF CONNECTOR TYPE N FEMALE BODY	28480	1250-0549
MP7	08742-0006	5	4	SPACER OUTER COND	28480	08742-0006
MP8	35676-62101	7	3	INNER CONDUCTOR ASSY-50 OHM	28480	35676-62101
MP9	35676-26301	3	1	HOUSING-SIGNAL DIVIDER	A01224	
MP10	35676-62102	8	1	INNER CONDUCTOR ASSY-75 OHM	28480	35676-62102
	0515-0999	9	14	SCREW-MACH M2.5 X 0.45 6MM-LG	77250	
	0515-0905	7	7	SCREW-MACH M2.5 X 0.45 6MM-LG PAN-HD	M01088	

OPERATIONAL VERIFICATION TEST RECORD

Hewlett-Packard Model 35676A 35676B (Circle One)
Reflection/Transmission Test Kit

Tests Performed By _____

Date _____

	Measurement	Tolerance
HP 3577A 200 MHZ Marker Value	_____	- 10 ± 1 dB (HP 35676A) - 15.7 ± 1 dB (HP 35676B)

or

Signal Generator Level (A)	_____	
Signal Divider Output Level (B)	_____	
Difference between B and A (B - A)	_____	- 10 ± 1 dB (HP 35676A) - 15.7 ± 1 dB (HP 35676B)